

vue d'ensemble

textile  
feutrine épaisse

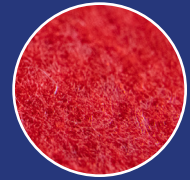

feutrine

textile conducteur

mousse

textile conducteur

bois 3mm

carton gris 1,5mm

bois 3mm

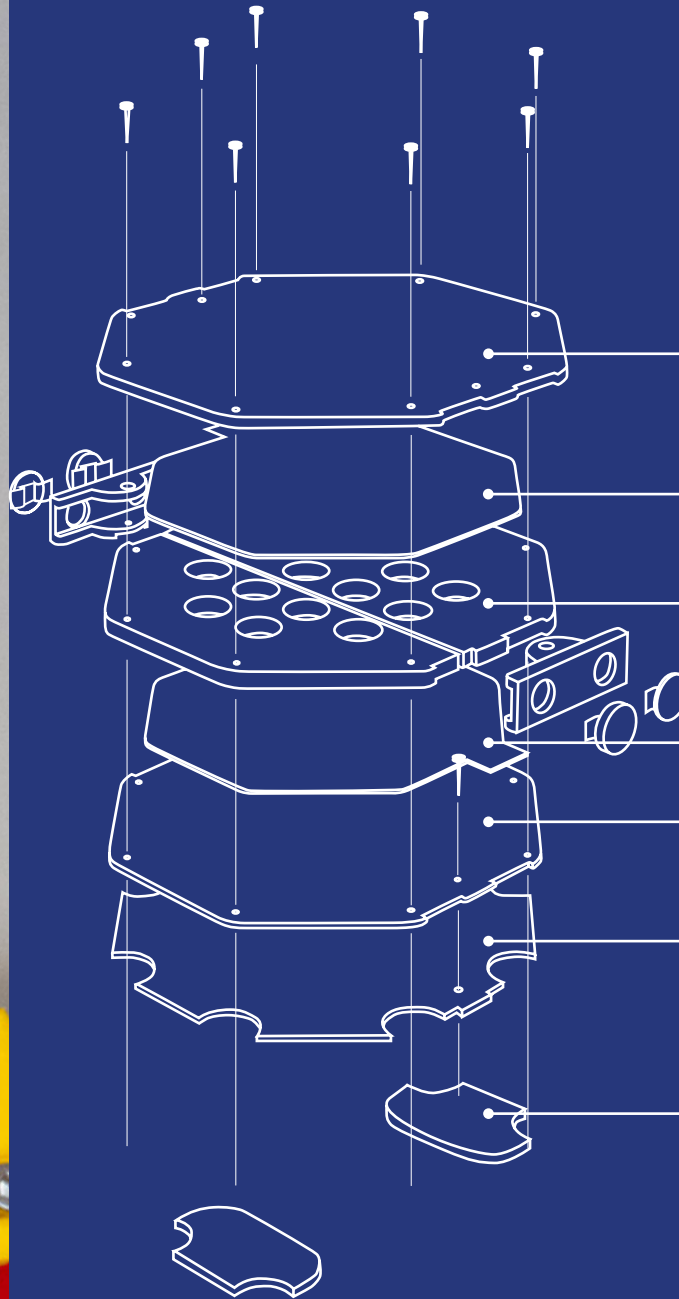

lm

learning matters

- taper -

circuit électronique

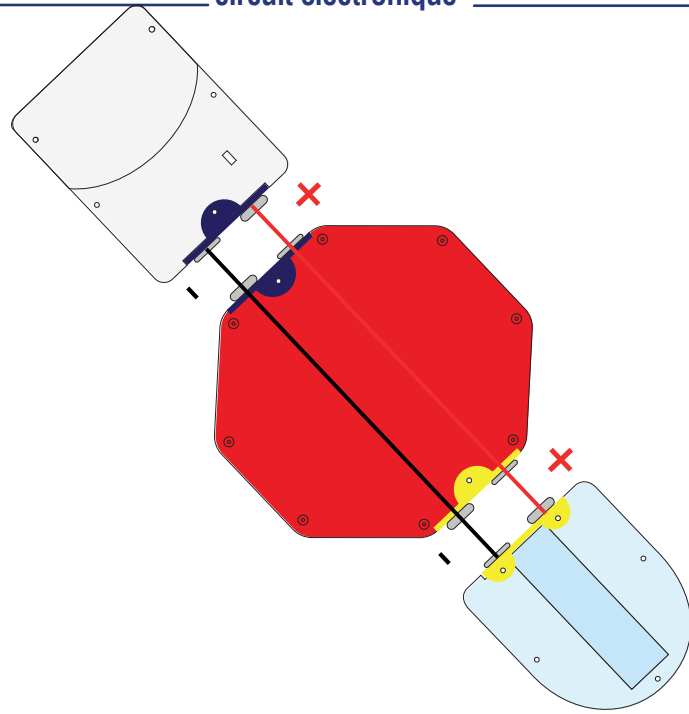

1

insérer

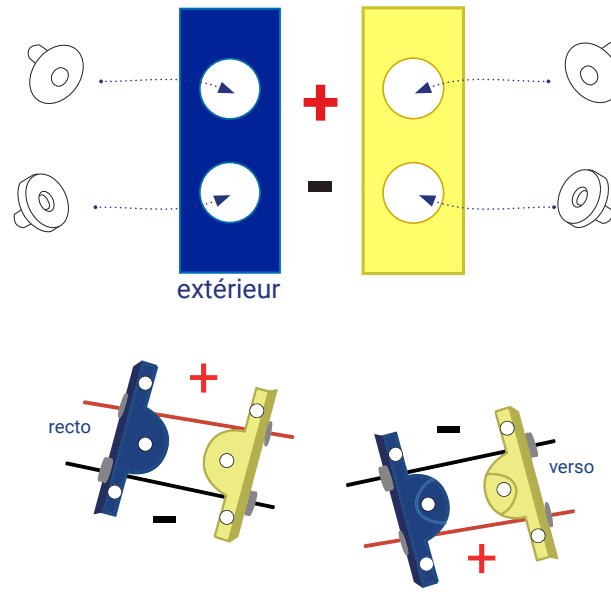

2

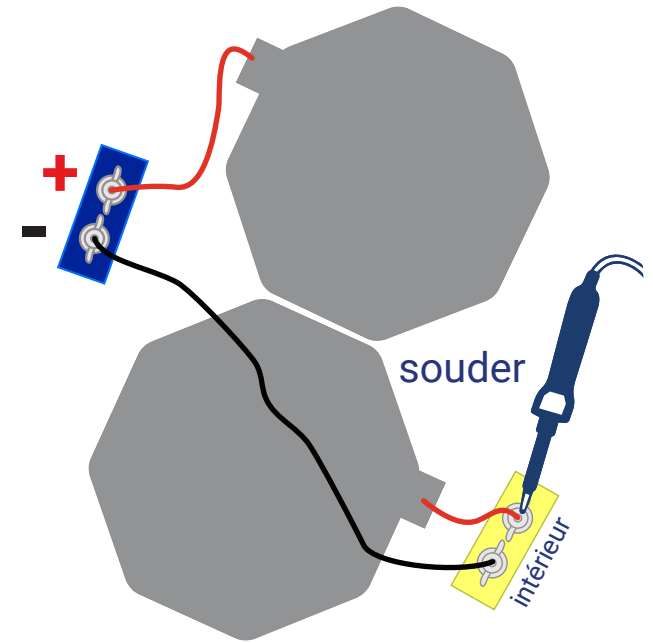

3

4

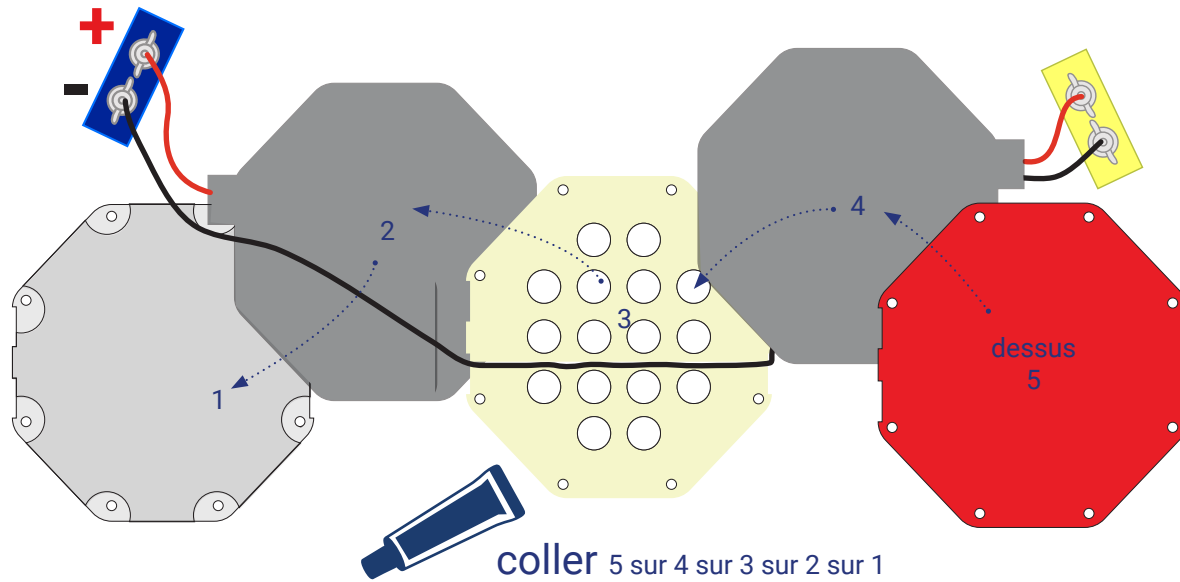

coller 5 sur 4 sur 3 sur 2 sur 1

(1) clipser  
les connecteurs  
jaune & bleu

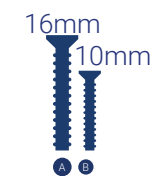
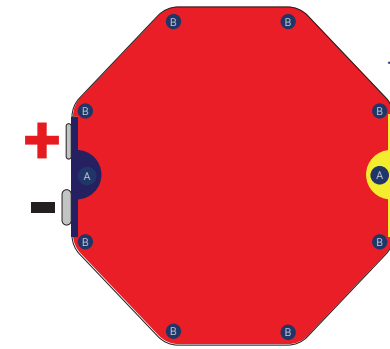

(2) visser  
à la main puis au  
tournevis étoile

