

vue d'ensemble

textile
velours

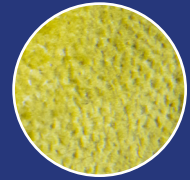

textile double de textile conducteur

textile

bois 3mm

bois 3mm

carton gris 1,5mm

bois 3mm

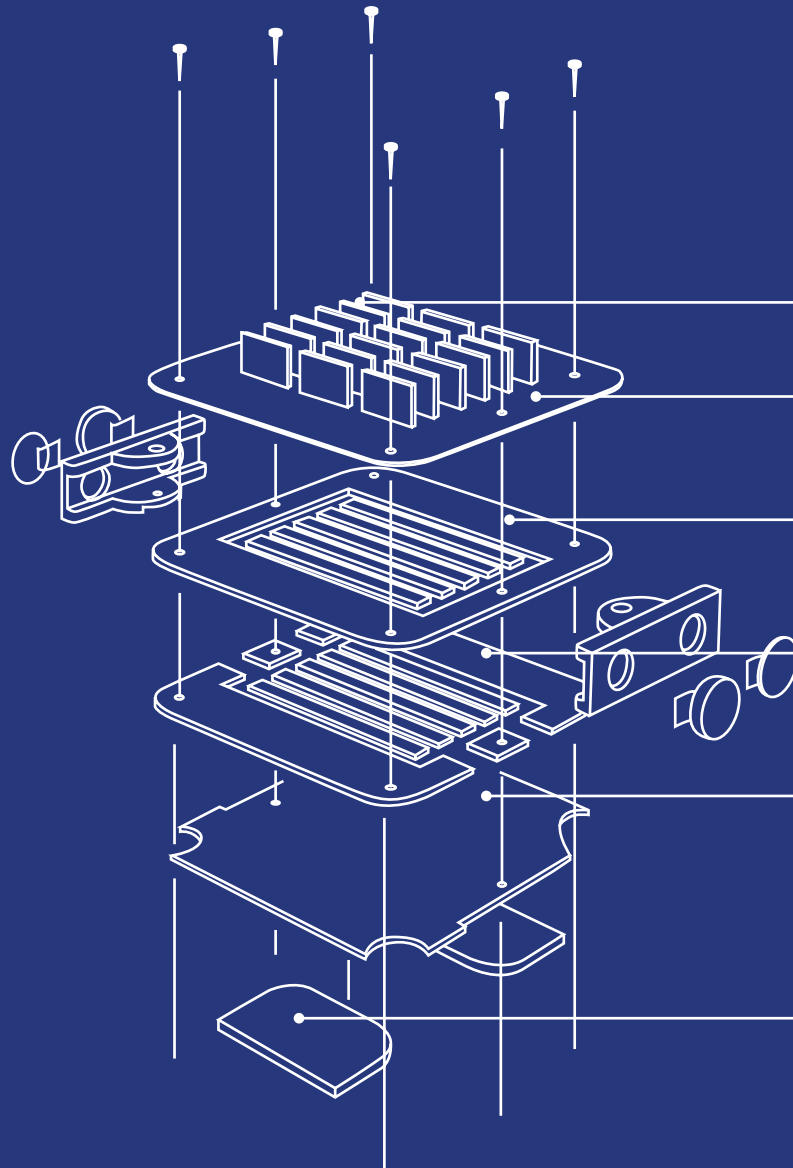

lm

learning matters
- caresser (easy) -

circuit électronique

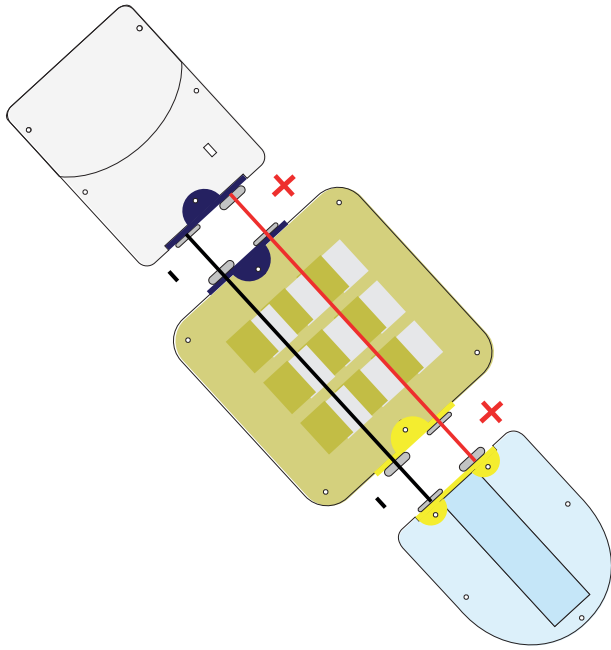

1
3

insérer

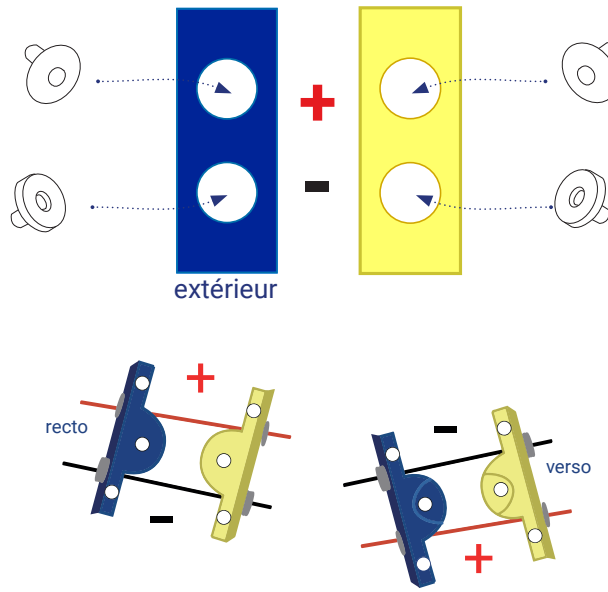

2
4

(1) insérer les languettes
tissu conducteur face à face
velours face à face

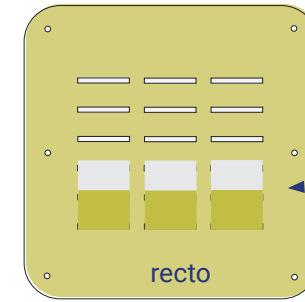

superposer & coller

(1) deux pièces de bois

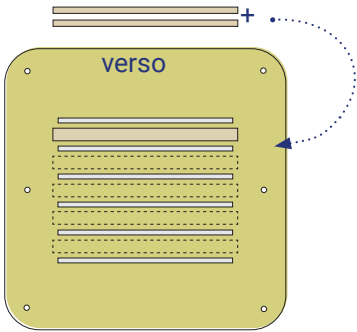

(2) connecter & souder
une languette de tissu
conducteur sur deux

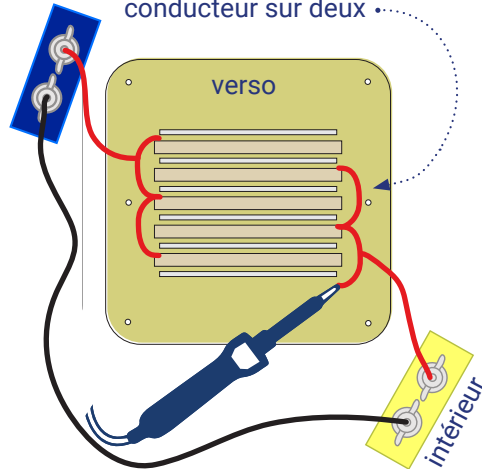

(3) coller
les trois pièces de bois
sur le verso pour recouvrir
les languettes

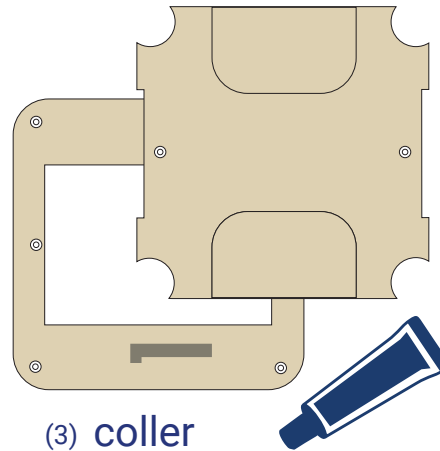

(1) clipser
les connecteurs bleu & jaune

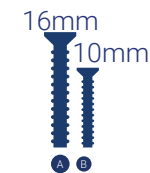
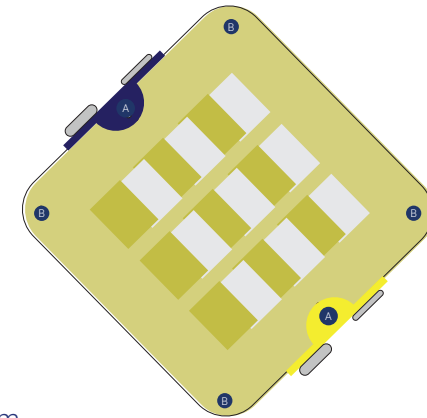

(2) visser
à la main puis au
tournevis étoile

